

ADDA 2402

User manual

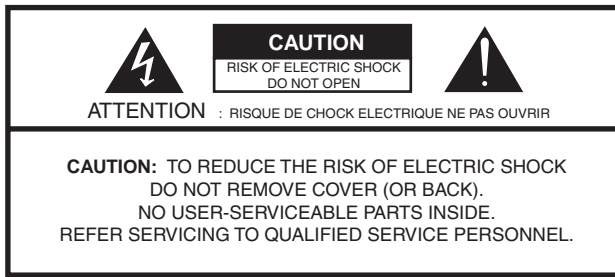



The lightning flash with arrowhead symbol, within an equilateral triangle, is intended to alert the user to the presence of uninsulated "dangerous voltage" within the product's enclosure that may be of sufficient magnitude to constitute a risk of electric shock to persons.



The exclamation point within an equilateral triangle is intended to alert the user to the presence of important operating and maintenance (servicing) instructions in the literature accompanying the product.

IMPORTANT SAFETY AND INSTALLATION INSTRUCTION SAVE THESE INSTRUCTIONS

INSTRUCTIONS PERTAINING TO RISK OF FIRE, ELECTRIC SHOCK, OR INJURY TO PERSONS

WARNING – when using electric products, basic precautions should be followed, including the following:

1. Read all of the safety and installations instructions and explanation of graphic symbols before using the product.
2. The product must be grounded. If it should malfunction or breakdown, grounding provides a path of least resistance or electric current to reduce the risk of electric shock. This product is equipped with a power supply cord having an equipment-grounding conductor and a grounding plug. The plug must be plugged into an appropriate outlet which is properly installed and grounded in accordance with all local codes and ordinances.

DANGER – Improper connection of the equipment-grounding can result in a risk of electric shock. Do not modify the plug provided with the product – if it will not fit the outlet have a proper outlet installed by a qualified electrician. Do not use an adapter which defeats the function of the equipment-grounding conductor. If you are in doubt as to whether the product is properly grounded, check with a qualified serviceman or electrician.

3. Do not use this product near water – for example, near a bathtub, washbowl, kitchen sink, in a wet basement, or near a swimming pool, or the like.
4. This product should only be used with a stand or cart that is recommended by the manufacture.
5. This product, either alone or in combination with an amplifier and speakers or headphones, may be capable of producing sound levels that could cause permanent hearing loss. Do not operate at a high volume level or at a level that is uncomfortable. If you experience any hearing loss or ringing in the ears, you should consult an audiologist.
6. The product should be located so that its location or position does not interfere with its proper ventilation.
7. The product should be located away from heat sources such as radiators, heat registers, or other products that produce heat.
8. The product should be connected to a power supply only of the type described in the operating instructions or as marked on the product.
9. The power-supply cord of the product should be unplugged from the outlet when left unused for a long period of time. When unplugging the power supply, do not pull on the cord, but grasp it by the plug.
10. Care should be taken so that objects do not fall and liquids are not spilled into the enclosure through openings.
11. The product should be serviced by qualified service personnel when:
 - A. The power supply cord or plug has been damaged, or
 - B. Objects have fallen, or liquid has spilled into the product, or
 - C. The product has been exposed to rain, or
 - D. The product does not appear to be operating normally or exhibits a marked change in performance, or
 - E. The product has been dropped, or the enclosure damaged.
12. Do not attempt to service the product beyond that described in the user maintenance instructions. All other servicing should be referred to qualified service personnel.
13. **WARNING** - Do not place objects on the power supply cord, or place the product in a position where anyone could trip over, walk on, or roll anything over cords of any type. Do not allow the product to rest on or be installed over cords of any type. Improper installations of this type create the possibility of a fire hazard and/or personal injury.

© 1999 All rights reserved. Digital Audio Denmark and ADDA 2402 are registered Trademarks of Digital Audio Denmark a/s.

Product features and specifications are subject to change without notice .

Digital Audio Denmark a/s shall not be liable for technical or editorial errors contained herein, nor for incidental or consequential damages resulting from the furnishing, performance or use of this manual.

Company Address: Digital Audio Denmark. PO Box 141. DK 2630 Taastrup.
Fax. +45 43 50 49 41. E-mail: info@digitalaudio.dk www.digitalaudio.dk

No. 973000020 rev. 1

Contents

1. INTRODUCTION	7
WELCOME	7
OVERVIEW OF ADDA 2402	7
2. INSTALLING THE ADDA 2402	9
BEFORE YOU START	9
INSTALLATION	9
<i>Connecting the Power Cable</i>	9
<i>Connecting the analog audio cables</i>	10
<i>Connecting the digital audio cables</i>	10
<i>Connecting the digital sync input</i>	10
USE THE ADDA 2402 AS A SMALL ANALOG/DIGITAL CROSS-FIELD	10
3. OPERATION	11
FRONT PANEL CONTROLS	11
<i>Analog Input</i>	11
<i>Digital Input</i>	11
<i>Digital Output Source</i>	11
<i>Sample Rate</i>	12
<i>Dither</i>	12
<i>Sync.</i>	12
<i>Power</i>	12
THE PEAK METER	12
4. BLOCK DIAGRAM	13
5. SPECIFICATIONS	15
ANALOG-TO-DIGITAL CONVERSION	15
DIGITAL-TO-ANALOG CONVERSION	17
DIGITAL-TO-DIGITAL CONVERSION	19
GENEREL	21
6. References	23
7. Appendix, Distortion Effects from Aliasing in Digital Audio	25

1. Introduction

Welcome

Congratulations, and thank you for purchasing the Digital Audio Denmark ADDA2402 audio converter. You have in your possession an extremely capable audio converter, which enables you to perform high-end analog-to-digital, digital-to-analog and digital-to-digital conversion of audio signals.

Overview of ADDA 2402

The ADDA2402 is a full duplex converter, which can perform independent simultaneous analog-to-digital (A/D), and digital-to-analog (D/A) conversion between analog audio signals and AES/EBU or S/PDIF digital audio signals. The digital interfaces comply to AES3¹.

The A/D converter converts an analog audio signal to a high quality digital signal with a sample-rate of 32 kHz, 44,1 kHz 48 kHz, 64 kHz, 88,2 kHz or 96 kHz, a noise floor below 117 dB(A)² at 44,1 Khz sampling, and a THD+N below 107 dB at 6 dBu input level.

The input level can be monitored on the Peak Programme Meter (PPM) at the front, and the input can be selected to be either the XLR connectors or Jack connectors.

The A/D conversion is 24 bit. Depending on the conversion application the A/D converter resolution can be reduced to 20 bit, 18 bit or 16 bit by adding psycho acoustic dither³ to the signal.

The bandwidth of the converted signal is equal to half the sample-rate, giving a bandwidth from 16 to 48 kHz. The filters in the A/D converter assure that no signal is present above half the sample-rate. This means that no aliasing distortion is introduced in the A/D converter. Having no alias components in the digital signal eliminates the risk of generation of Alias Intermodulation Distortion (AID)⁴.

The D/A converter converts a digital audio signal to a high quality analog signal having a dynamic range better than 117 dB(A) at 44,1 Khz sampling, and a THD+N below 90 dB at 6 dBu output level.

You can chose between three digital input sources, either a professional AES/EBU signal on XLR connectors, a consumer S/PDIF signal on Phone connectors or an optical S/PDIF signal on a TosLink connector.

The D/A converter automatically adapts to the sample-rate of the incoming digital signal which can be 32 kHz, 44,1 kHz 48 kHz, 64 kHz, 88,2 kHz or 96 kHz.

The ADDA 2402 can also be configured as a digital-to-digital (D/D) converter for sample-rate conversion (SRC) of a digital input of a given sample-rate and format to a digital output of an other sample-rate and format.

The converter can do sample-rate conversion between any of the six sample-rates from 32 kHz, 44,1 kHz 48 kHz, 64 kHz, 88,2 kHz to 96 kHz, and convert between the professional and the consumer AES/EBU format.

ADDA 2402 has high precision internal oscillators with a stability of +/- 5 parts per million (PPM) controlling the sample-rates. The ADDA2402 can also be synchronised to an external reference signal complying with AES 11⁵.

¹ Please refer to section 5, references for an explanation of AES 3.

Please refer to section 3, The peak meter for a description of the input levels and the dB notification.

³ Please refer to section 5, references for an explanation of the psycho acoustic dither.

⁴ Please refer to Appendix 1 for a description of AID.

⁵ Please refer to section 5, references for an explanation of AES 11.

1. Installing the ADDA 2402

Here is a quick description of all the basic things you need to cover to get started with your ADDA 2402.

Before You start

- Make sure the ADDA 2402's voltage matches the voltage in your location. The ADDA 2402 is labelled on the AC power connector with the main voltage setting which can be either 110-120V, 220-240V or 110-240 V at 50-60 Hz.
- Set your ADDA 2402 on a hard and dry surface or mount it onto a 19" rack, and leave plenty of room for ventilation.
- In order to meet the EMC requirements of Directives 89/336/EEC and 93/68/EEC, and in order to obtain the high performance possible for the ADDA 2402, you must use correctly shielded cable of good quality for all external connections, when installing the ADDA 2402. For the power connection a normal un-shielded cable can be used. Make sure that the XLR, Phono and Jack connectors have conductive houses connected to the shield.
- Make sure your sound system is at a safe volume level.

Installation

This section will take you through the installation of your ADDA 2402. We will describe the power, audio and digital cable connections, which can be accessed on the rear panel.

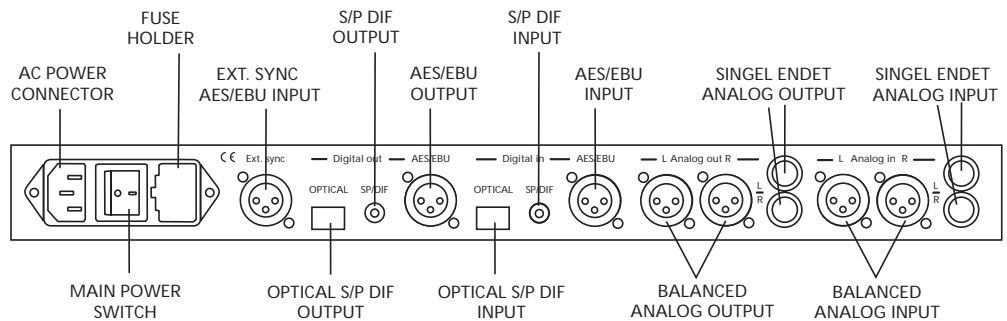

Connecting the Power Cable

The ADDA 2402 runs on 50-60 Hz AC voltage, and is set from the factory to, 110-120 V, 220-240 V or 110-240 V. Excessive voltages can seriously damage the ADDA 2402, so make sure that your AC power matches the setting of your ADDA 2402.

When you connect the power use the cable you received together with your ADDA 2402 and plug it into a grounded outlet.

If your power source does not have the standard three-hole outlet, you should take the time to get installed a proper grounding system. This will prevent problems with audio hum, and will reduce the risk of a shock hazard. Furthermore it is required that the converter is grounded in order to fulfill both the safety requirements and the EMC requirements.

Connecting the analog audio cables

After you have turned down the level on your sound system, you can rig the ADDA 2402's analog audio cables. You will find two balanced XLR input connectors marked **L-Analog in-R**. On The right side of the XLR input connectors you will find two Jack input connectors marked **L/R** for unbalanced input. The maximum input level for giving a full scale digital signal is + 18 dBu on the balanced input and + 4 dBu on the unbalanced input.

You can use either the XLR input or the Jack input as the analog audio input source, or you can have both inputs connected. The active input source is selected on the front panel.

You will also find two balanced XLR output connectors marked **L Analog out R**. On The right side of the XLR output you will find two unbalanced Jack output connectors marked **L/R**. The output level equivalent to a full scale digital input signal is + 18 dBu on the balanced output and + 4 dBu on the unbalanced output

The ADDA 2402 will generate an output signal on both the XLR and the Jack output simultaneously, so you can interface to your mixing board and the analog input of a keyboard simultaneously.

Connecting the digital audio cables

On the rear panel you will find a digital input section with an optical TosLink, an S/P DIF input connector and an AES/EBU input connector, marked **Digital in, Optical, S/P DIF** and **AES/EBU**.

Connect one, two or all of them to the digital output on your DAT recorder, your CD player or/ and your harddisk recording system, and use the front panel to switch between the input sources.

You will also find a Digital Output section with an Optical TosLink, an S/PDIF output connector and an AES/EBU output connector, marked **Digital out, Optical, S/P DIF** and **AES/EBU**.

The ADDA 2402 generates an output signal on all digital output simultaneously, so you can interface to the digital input on your DAT, keyboard or/and your harddisk recording system, and use your DAT, keyboard and harddisk recording system to switch between them.

Connecting the digital sync input

On the left side of the main power connection you will find the AES11 external synchronisation input connector, marked **Ext. sync**. If you are using an AES11 studio master clock, you can connect this input to your AES11 master sync. output. The ADDA 2402 will be able to synchronise the sample-rate to the sync. signal.

Use the ADDA 2402 as a small analog/digital cross-field

You can use your ADDA 2402 as a small analog/digital cross-field by connecting your different studio equipment as shown below.

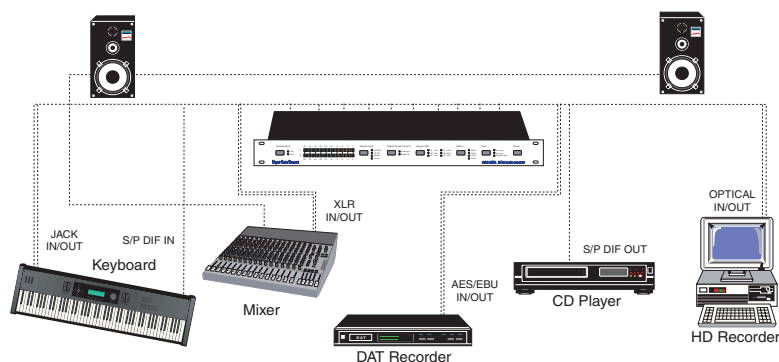

2. Operation

When you have connected the power and the audio cables, you can activate the main switch on the rear panel in order to turn on the ADDA 2402.

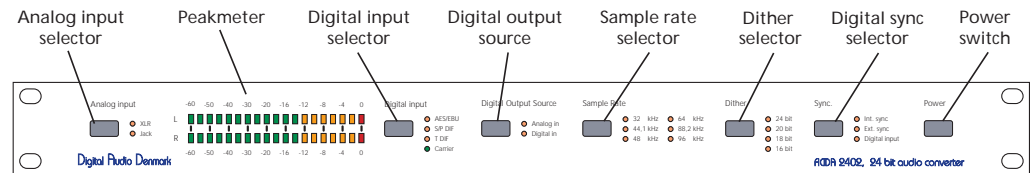

After start-up the ADDA 2402 has to calibrate for about 20 seconds. It is recommended to leave the ADDA 2402 on for approximately 5 minutes in order to warm up, and then activate the sample-rate selection or digital input source switch. This will cause the converter to recalibrate, and improve the dynamic range in a region of 1 to 2 dB. During the start-up calibration process the -60 dB LEDs of the PPM lights up, and the **Int. Sync** and **Ext. Sync LED** will blink slowly.

The ADDA 2402 has a non-volatile memory system enabling the converter to remember the active settings. After a power up, the ADDA 2402 will restore the settings from before it was powered down.

Front Panel Controls

The buttons on the front panel control the mode of operation of the ADDA 2402. All settings are shown by light diode indicators (LEDs). Each time a button is activated the corresponding mode will change between the possible settings.

Analog Input

On the **Analog Input** button you can switch between the balanced XLR input and unbalanced Jack input. The input signal will be converted to a digital signal when the **Digital Output Source** mode is set to analog in. The digital signal is available on the AES/EBU, S/PDIF and the optical output connectors.

Digital Input

On the **Digital Input Source** button you can select which of the digital inputs you would like to be active. You can choose between AES/EBU, S/PDIF and Optical (TosLink). The digital input chosen will always be converted to an analog signal and sent to balanced and unbalanced analog output connectors. This means the DA converter in the ADDA 2402 will always be active, if there is a digital input signal, no matter what other mode you use for some of the other buttons (except the power button of course).

If there is a valid digital input signal on the selected digital input, the “Carrier” LED will light up.

Digital Output Source

On the **Digital Output Source** button you can choose between analog and digital input. If you choose analog input, the ADDA 2402 will convert your analog input to a digital output. If you choose digital input, the ADDA 2402 will work as a sample-rate converter, and convert the digital input to the sample-rate you have chosen on the **Sample Rate** button.

Sample Rate

On the **Sample Rate** button you can select the sample-rate of the A/D converter between 32 kHz, 44.1 kHz, 46 kHz, 64 kHz, 88.2 kHz and 96 kHz. When a sample-rate has been selected, the A/D converter will take about 3 seconds to calibrate before it is ready for operation. The sample-rate LEDs will always show the selected sample-rate. When an external synchronisation is selected via the **Ext. sync** button, the sample-rate LEDs indicate the sample-rate of the received external synchronisation signal.

Dither

On the **Dither** button you can select the amount of dither added to the audio signal when sampled by the A/D or the D/D converter. The dither setting has to correspond to the bit resolution of the digital system to which the digital output of the converter is connected. If the audio signal is sampled in 24 bit resolution and connected to a 16 bit hard disk recording system, the noise behaviour of the recorded signal will not be optimal, and a clicking in the sound can occur. Therefore it is important to set a correct bit resolution.

Sync.

On the **Sync.** button you can select the synchronisation source for the A/D converter sample-rate. The source can be Int. Sync which is the internal +/-5ppm precision oscillator. External synchronisation, which is the AES11 reference, signal connected to the Ext. Sync. input connector on the rear panel. Finally, the synchronisation source can be the digital input selected via the digital input button. If no Ext. Sync or digital input source is connected to the ADDA 2402 the source can not be selected via the Sync. button. If a selected external synchronisation source fails, the ADDA 2402 will automatically default to Int.Sync.. If the signal is re-established the ADDA 2402 will automatically switch to the selected source unless the synchronisation mode has been changed.

It is possible to detect the sample-rate of an incoming digital signal. Set the digital **Sync** selector in digital input mode and use the **Digital Input** selector to select the digital input source you want to detect. The sample-rate LEDs will now indicate the incoming sample rate. Please note that an incoming signal with a sample-rate of 64 kHz will be indicated as a 48 kHz signal, because 64 kHz is not defined in AES3 as a valid sample-rate (however the converter will D-to-A convert an incoming 64 kHz digital signal correctly).

Power

On the **Power** button on the right side of the front panel the converter can be set to a stand-by mode, where the power to the electronic circuits are disabled. By pressing the Power Button in stand-by mode, the converter re-enters the operation mode, with all power restored. If the main switch on the rear panel is switched off there will be no power on the ADDA 2402.

The Peak Meter

The ADDA 2402 is equipped with a very precise Fast Peak Programme Meter (PPM) for monitoring the level of the analog input signal. The PPM indicates the fast peak value of the signal with an integration time of 10ms for full scale reading according to IEC 268-10. The meter has a hold time of 1 second for levels from -12 dBFS to 0 dBFS. Levels below -12 dBFS has no hold function.

The peak meter reads out the fast peak value of the input signal in dB full-scale (dBFS), where reading is relative to the full-scale value of the digital signal. This means that for the XLR input an analog level of +18 dBu, which is 6.16Volt RMS, will give a 0dBFS reading. A red LED indicates 0dBFS. For -20 dBFS to 0dBFS the readout resolution is 2dB. From -12 dBFS to -2dBFS the readout is indicated by green LEDs.

The peak meter can **store** the highest peak in a recording by pushing the analog input selector rapidly twice. The diode for XLR or Jack will flash, and the highest peak will continue to light up. To release the peak meter just press the analog input selector rapidly twice again. It is recommended to adjust the input signal to a maximum, peak value of -12dBFS . This means that the meter normally reads out 'green' values. In this way a 12 dB headroom is preserved, thus giving a nominal input level of $+6\text{dBu}$ (1.55 V RMS). The meter will read down to -60dBFS , but still the A/D converter will have a dynamic range better than 116 dB (A). With a 12 dB headroom, the noise floor will thus be below 104 dBrel(A) to the nominal level of 6dBu (0dBrel).

3. Block diagram

The following figure shows a block diagram of the ADDA 2402.

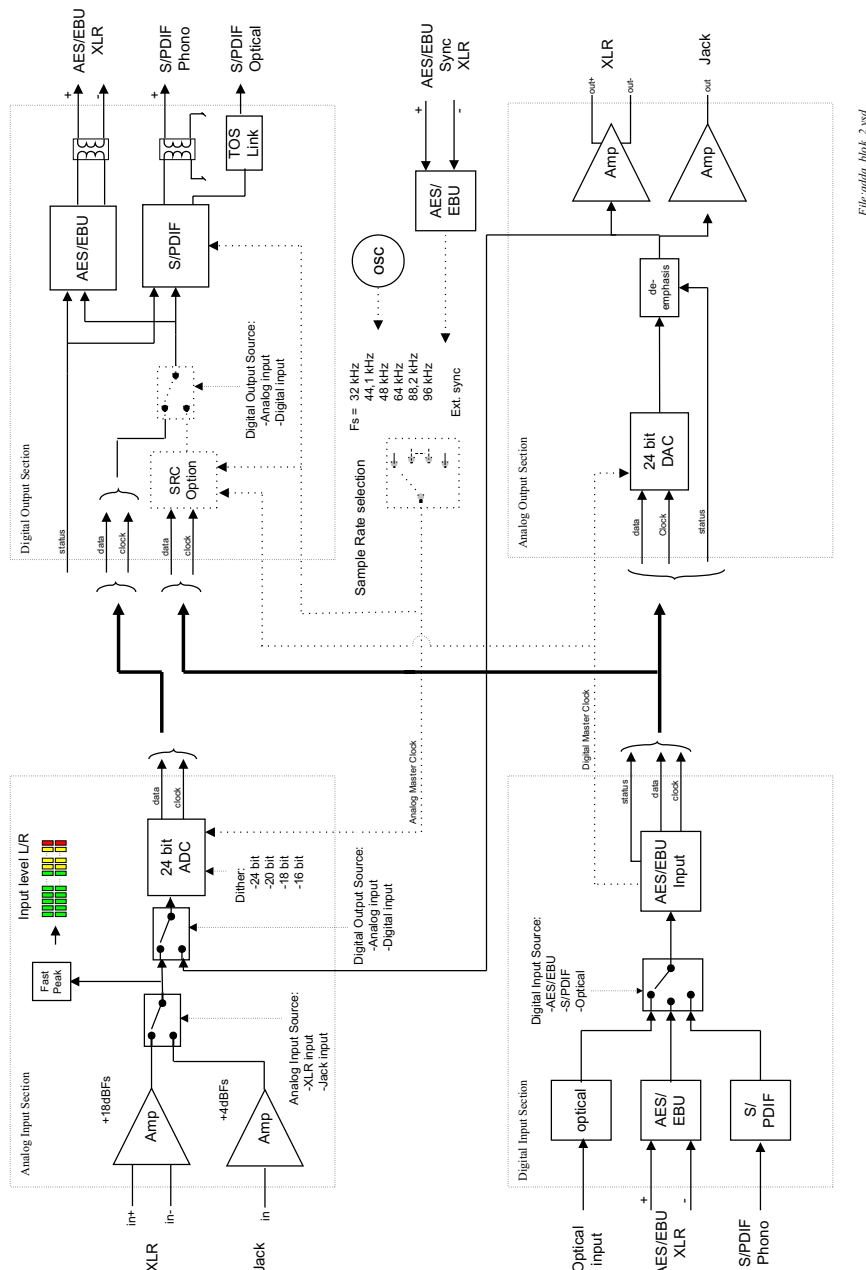

4. Specifications:

Analog to Digital Audio Conversion

Cross-talk:

- Cross-talk at 997 Hz, -3 db Fs < 110 dB

Processing delay:

- Processing delay < 1,0 ms

Frequency response

- Fs 32kHz, 18 Hz-13,5 kHz:±0.1dB
- Fs 44,1kHz, 18 Hz-18,8 kHz:±0.1dB
- Fs 48kHz, 18 Hz-20,0 kHz:±0.1dB
- Fs 64kHz, 18 Hz-25,0 kHz:±0.1dB
- Fs 88,2kHz, 18 Hz-35,0 kHz:±0.1dB
- Fs 96kHz, 18 Hz-38,0 kHz:±0.1dB

The frequency response has a Stop-band attenuation of 117 dB at half the sampling frequency, thus eliminating high-frequency aliasing.

Dynamic range

The Dynamic Range is better than 117 dB (A-weighted) at 44,1 kHz sampling. The dynamic range with a -60 dB FS input signal is better than 140 dB measured as a FFT.

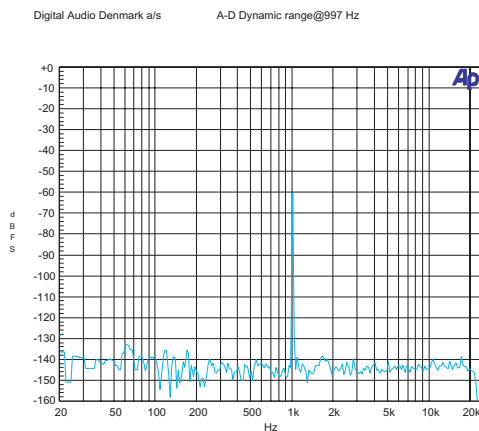

THD+Noise

The THD+N vs. input amplitude is shown in the figure below. At a nominal input level of 6 dBu, the THD+N is below -104 dB.

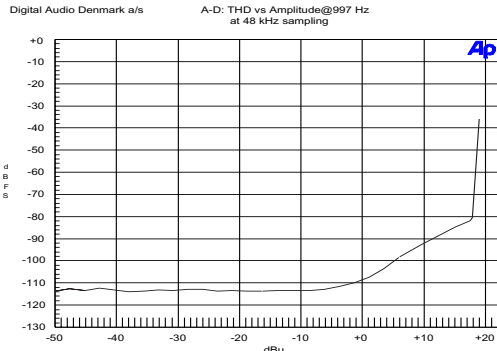

Residual noise

The residual noise floor is better than -140 dB.

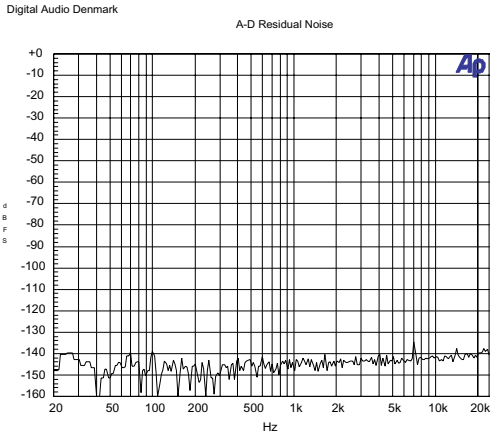

Linearity

Linearity better than +/- 0,5 dB down-to -105 dB

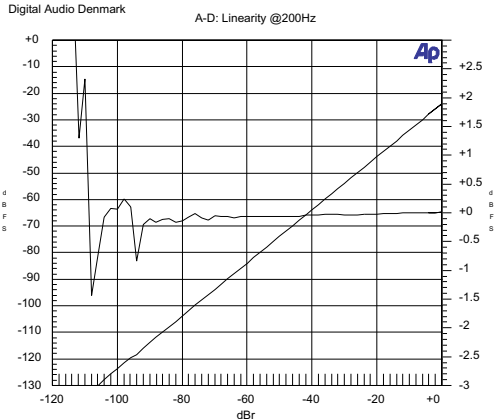

Digital to Analog Audio Conversion

Cross-talk:

- Cross-talk at 997 Hz, -3 dB Fs < 100dB

Processing delay

- Processing delay < 0,85ms

Frequency response

- Fs 32kHz, 18 Hz–14,5 kHz:±0.1dB
- Fs 44,1kHz, 18 Hz–20,0 kHz:±0.1dB
- Fs 48kHz, 18 Hz–22,0 kHz:±0.1dB
- Fs 64kHz, 18 Hz–30,0 kHz:±0.1dB
- Fs 88,2kHz, 18 Hz–39,0 kHz:±0.1dB
- Fs 96kHz, 18 Hz–42,0 kHz:±0.1dB

Dynamic range

The dynamic range is better than 117 dB (A-weighted) at 44,1 kHz sampling. The dynamic range with a -60 dB FS input signal is better than 140 dB measured as a FFT.

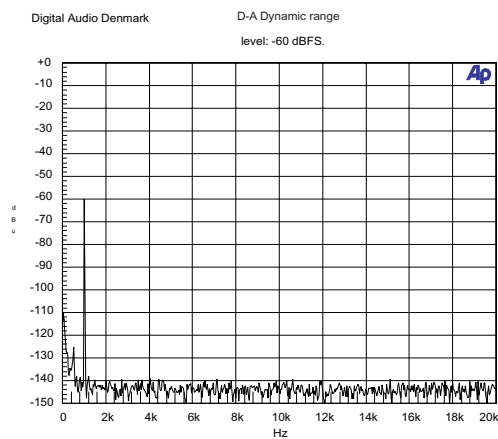

THD+Noise

THD+N output signal is measured relative to a nominal output level of 6 dBu,
THD+N is below 90 dB.

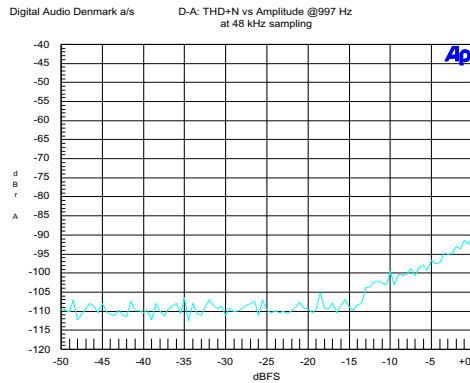

Linearity

Linearity better than $\pm 0,5$ dB down-to -105 dB. The output level is relative to 18 dBu.

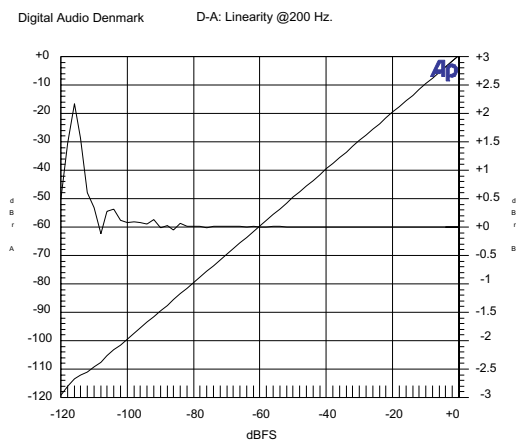

Digital to Digital Audio Conversion

Cross-talk:

- Cross-talk at 997 Hz, 3 dB Fs < 100dB

Processing delay:

- Processing delay 2,0 ms

Frequency response

44,1 to 48 kHz	18 Hz-19,0 kHz
44,1 to 96 kHz	18 Hz-21,0 kHz

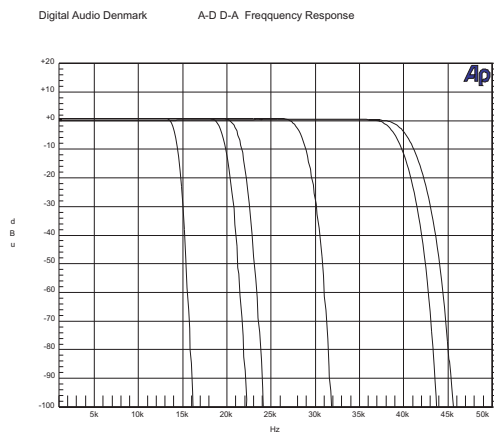

Dynamic range

When measured A-weighted the dynamic range is better than 112 dB.

Linearity

Linearity better than +/- 0,5 dB down-to -110 dB.

Insertion gain:

At sample-rates from	
32 to 48kHz:	-1,0 dB
64 to 96kHz:	-1,5 dB

General specifications

DIGITAL INPUTS AND OUTPUTS

Connectors:	XLR, RCA Phono, Optical
Formats:	AES/EBU, S/PDIF
Sample Rates:	32 to 96 KHz
Ext. Sync:	XLR, 32 to 96 kHz
AES/EBU:	Acc. to AES3
S/PDIF:	Acc. to IEC 958
Ext. Sync input	Acc. to AES11

Digital audio signal is available on all three digital outputs simultaneously.

ANALOG INPUTS

Connectors:	XLR (pin 2 hot, pin 3 cold, pin 1 ground), Jack
Impedance (Balanced):	> 5 k Ohm
Impedance (Un-balanced):	> 20 k Ohm
Max. Input Level (Balanced)	+18 dBu
Max. Input Level (Un-balanced)	+ 4 dBu

ANALOG OUTPUTS

Connectors:	XLR (pin 2 hot, pin 3 cold, pin 1 ground), Jack
Impedance (Balanced):	< 40 Ohm
Impedance (Un-balanced):	< 20 Ohm
Max. Output Level (Balanced):	+18 dBu
Max. Output Level (Un-balanced):	+ 4 dBu

GENERAL

EMC complies with:	EN 50082, and EN 500022
Operating Temperature:	+5 to 45° C
Dimensions (w,h,d):	19", 1U, 275 mm
Weight:	3,3 kg
Mains Voltage:	110 - 120 VAC or 220 - 240 VAC
Power Consumption:	10 Watts

Due to our policy of continuous improvement of our products, Digital Audio Denmark reserves the right to make feature and specifications changes without notice.

7. References

- AES3 AES3-1992: “AES Recommended Practice for Digital Audio Engineering – Serial transmission for two-channel linearly represented digital audio data” Published by Audio Engineering Society, Inc.
AES3 is a specification of the AES/EBU digital audio format. AES3 specifies the frame format for the audio data in both professional and consumer mode, as well as the electrical interface for the professional balanced XLR connection. AES3 is however primarily a professional standard. The detailed specification for the consumer interface is IEC 60958.
- IEC958 IEC 60958 1989: “Digital Audio Interface”. Published by the International Electrotechnical Commission.
IEC958 is a specification of the consumer AES/EBU digital audio format also referred to as S/PDIF. IEC958 specifies the frame format for the audio data in consumer mode, as well as the electrical interface for the unbalanced data connection.
- AES11 AE11-1991: “AES Recommended Practice for Digital Audio Engineering – Synchronization of Digital Audio Equipment in Studio Operations”. Published by Audio Engineering Society, Inc.
AES11 is a recommendation for synchronization of digital audio signals. Recommendations are made concerning the accuracy of sample clocks as embodied in the digital interface signal, and concerning the use of this as a convenient reference signal.
- EN50082 EN 50082-1: “Electromagnetic compatibility – generic immunity standard, part 2: Residential, commercial and light industry”. Published by CENELEC 1992. Note that the standard also covers EN 50081-1 (part 1).
EN 50082-1 is the standard specifying the requirements for CE compliance concerning Immunity following the EEC provisions of directives 92/31/EEC.
- EN500022 EN 500022-1: “Limits and methods of measurement of radio interference characteristics of immunity” Published by CENELEC 1987.
EN 500022-1 is the standard specifying the requirements for CE compliance concerning Emission following the EEC provisions of directives 89/336/EEC.
- IEC 268-10 IEC 60268-10: edition 2.0 “Sound system equipment – part 10. Peak programme level meters” Published by the International Electrotechnical Commission 1991-03.
EN 60268-10 is the standard specifying the requirements of audio-frequency peak programme level meters, for use in equipment for broadcasting, sound reinforcement, sound recording, and household entertainment.
- DITHER The dither of the ADDA 2402 is implemented by using a psychoacoustic noise shaping filter for truncating the 24 bit audio word to 16, 18 or 20 bits, while the 24 bit sound quality is preserved. A detailed description of the dither algorithm can be found in the AES paper: “Psychoacoustically Optimal Noise Shaping” by Robert A. Wannamaker, Journal of the Audio Engineering Society, Vol 40, No 7/8, 1992 July/August.

Distortion Effects from Aliasing in Digital Audio

Mikael Vest and Peter Scheelke
Digital Audio Denmark
www.digitalaudio.dk

ABSTRACT

When converting audio between the analog and digital audio domains, the well-known effects from alias signals have to be taken into consideration. Generally, audio converters do not have adequate filtering to eliminate this kind of spectral distortion. During recent works it has been concluded that the sound quality of digital recordings can be drastically improved when applying efficient stop-band filtering.

INTRODUCTION

When converting an analog signal to a digital signal, the analog signal is sampled with a frequency of twice the bandwidth that is required for the digital representation. To get an optimal sampling, the bandwidth of the analog signal must not exceed half the sampling frequency, also referred to as the Nyquist frequency (NF). If frequency contents are present above the NF, a mirror of the frequencies is generated at frequencies symmetrical to the NF and new frequencies are thus generated with no harmonic relationship to the tonal contents of the original signal. This phenomenon is referred to as aliasing distortion. If the distortion is only present at high frequencies, it is not likely that it can be heard, and therefore it will not degrade the signal quality. However, when the digital signal has to be reproduced using D/A converters, amplifiers and indeed analog transducers such as loudspeakers will introduce intermodulation distortion (IMD) to the signal. IMD means that the frequencies of the signal mix together and generate new frequencies, which can be audible if the distortion exceeds certain levels. The problem is now that when new a-tonal frequencies are added to the signal due to aliasing distortion, such signals will mix very badly with the rest of the program and thus be audible.

The important fact of this problem is that distortion happens when the signal has both aliasing distortion and IMD above a certain level. Of course, it depends on the quality of the sampling and the quality of the reproduction equipment, and in particular the loudspeakers. This effect is referred to as Aliasing Intermodulation Distortion (AID).

Over the years discussions and papers on sound quality of digital recorded material have been many. However, at the 106th AES Convention in Munich a new thesis was presented by Mr. Richard Black [1] stating the problems of this combined distortion phenomenon.

This paper has the purpose of explaining the basis of this distortion type, which he had recently identified.

Today high quality audio A/D converters are typically based on the delta-sigma conversion principle with 64/128 times over sampling and internal digital filtering. According to the manufacturers of the converter chipset, this removes the need for an external anti-alias filter. However the filters normally implemented are so called 0.45/0.55 times the sample frequency (FS) filters. This means that the pass band goes to 0.45xFS, and the stop-band starts from 0.55xFS. In Figure 1 the frequency response is shown with 44.1 kHz and 48 kHz sample frequency.

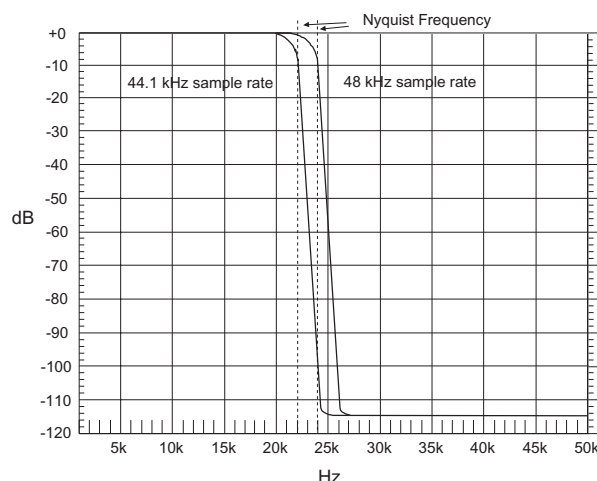

Figure 1, Frequency response of 0.45/0.55xFS filter

In the case of FS = 44,1 kHz, the stop-band will only be effective at 24,26 kHz, and the attenuation at the NF is approx. 8.5 dB. In Figure 2 a close-up of the transition band frequency response is shown.

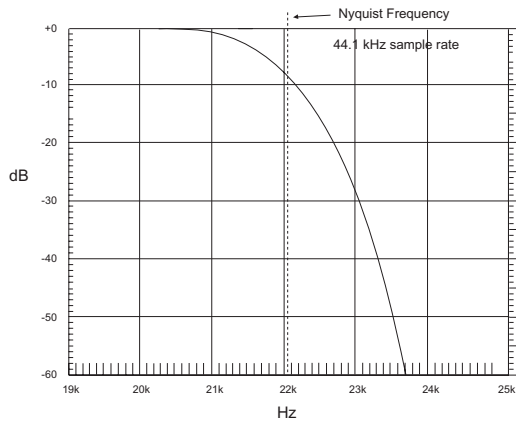

Figure 2, Transition band of 0.45/0.55xFS filter

According to the classic theory on sampling of analog signals, the spectrum of the signal will be mirrored round the NF and repeated for each multiple of the NF, as shown in Figure 3.

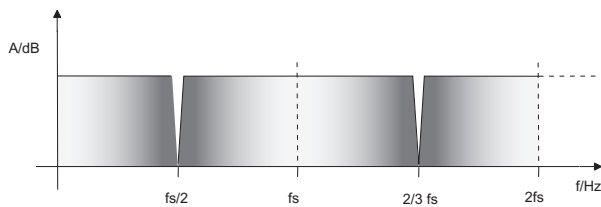

Figure 3, Spectrum of a sampled signal

If signal contents are available in the signal above the NF a mirror of the signal will fold down below the NF as an alias signal, and thus generate aliasing distortion. If a broadband signal is sampled with a 0.45/0.55 anti-alias filter, the spectrum can act as shown in the example in Figure 4.

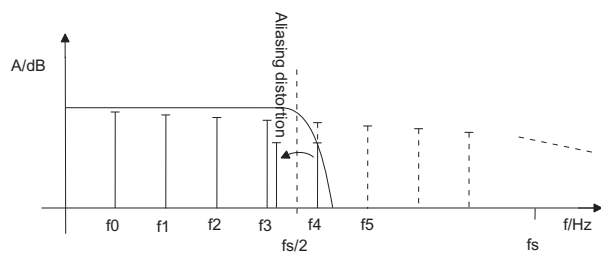

Figure 4, Aliasing distortion example

The example shows a signal with a fundamental frequency of f_0 and a number of harmonics. The 4th harmonic is just above the NF, but still in the transition band of the anti-alias filter of the A/D converter.

When the signal is sampled with an A/D converter having an anti-alias filter, with stop-band attenuation at the NF, no aliasing distortion appears.

INTERMODULATION DISTORTION

Intermodulation distortion is a type of distortion where non-linearities in the signal path generate modulation between all the frequency components of the signal. The primary source for IM distortion in the audio signal path is the loudspeaker. This is due to the non-linear behaviour of the speaker cone, which of course depends on the loudspeaker type and quality.

Modulation means that new frequencies f_{im} are generated from all positive combinations of two existing frequencies.

$$f_{im} = | \pm f_1 \pm f_2 |$$

If two frequencies are denominated f_1 and f_2 , where $f_2 > f_1$, and assuming $f_2 < 2f_1$, the modulation frequencies generated are as shown in Table 1.

	f_2	$2f_2$	$3f_2$
f_1	$f_2 - f_1$	$2f_2 - 2f_1$	$3f_2 - f_1$
$2f_1$	$2f_1 - f_2$	$2f_2 - 2f_1$	$3f_2 - 2f_1$
$3f_1$	$3f_1 - f_2$	$3f_2 - 2f_1$	$3f_2 - 3f_1$

Table 1, IM frequencies

IM distortion will appear up to a very high order, but third order IM distortion is the highest order that has any significance in this application. The magnitude of the modulation products is reduced when the modulation order rises. The non-shaded areas in the table are the modulation products with the highest relevance.

IM distortion will generate a-harmonic signals when aliasing distortion is present, since the alias signal will modulate with the harmonics of the original signal. Depending on the frequency contents of the signal spectrum, some modulation frequencies will be more audible than others. If an IM frequency is near the fundamental frequency for the tonal spectrum, the effects will be quite annoying, unless the IM frequency is within the masking area, in which case it will not be heard. An example of IM distortion is shown in Figure 5.

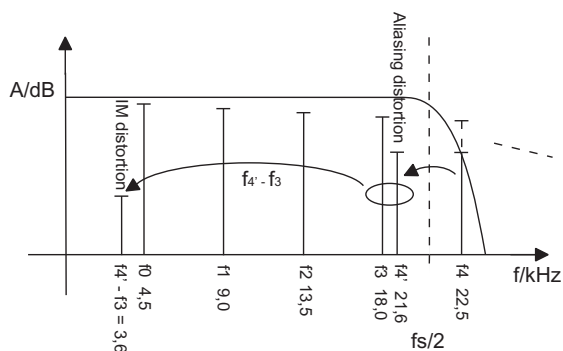

Figure 5, IM distortion example

In this case the 4th overtone of a fundamental tone of 4.5 kHz will generate aliasing distortion at 21.6 kHz. This frequency will modulate with the other tones in the signal spectrum, and first order modulation with the 3rd overtone will then generate a modulation frequency of 3.6 kHz, which is likely to be audible and make interference with the original signal. IM distortion coming from modulation between the harmonics of the signal will not generate a-harmonic distortion signals, since the IM products will have frequencies equal to the harmonic of the signal, and will therefore not be audible.

DVD audio

Recently the new sampling 96 kHz format has been defined. This format is meant to be used in the music production environments, and as the DVD linear audio format. Generally, there is an acceptance that this higher sample-rate gives a better sound quality due to the extended signal bandwidth from 48 kHz to 96 kHz. However, sampling with 96 kHz having 0.45/0.55 filters – which is currently the case for most converters – the aliasing distortion will move up in a frequency area where the IM distortion has very little effect since the harmonic contents of audio signals are insignificant above 40 kHz. An interesting test is to compare the 96 kHz sampled signals with the 44,1 kHz sampled signals having NF stop-band filtering. At 96 kHz sampling the ultra-sonic harmonics will be present in the signal giving a better quality than when sampled with 44.1/48 kHz even with a NF stop-band filter applied. However the primary issue when considering the different sample-rates for high quality sampling is to avoid AID, more than having a higher sample-rate.

SUMMARY

When converting audio from the analog to the digital domain, care has to be taken that stop-band filtering is applied in order to avoid aliasing distortion in the digital audio signal. Once the signal is converted to digital, the aliasing distortion products can not be removed with-out reducing the bandwidth accordingly. The aliasing distortion will, when the signal is reproduced on a set of loudspeakers having some IM distortion, generate AID. Of course good loudspeakers have lower distortion, but most hi-fi speakers will have IM distortion thus giving audible AID.

The only way to eliminate the problem with AID is to apply stop-band filtering on the A/D conversion. If this is not done AID will cause different problems depending on the application for the sampled digital audio signal.

When using 44.1/32 kHz sample-rates, the NF is close to/within the audible frequency band. This is a problem for the Compact Disc (CD). Since CDs are mastered in 44.1 kHz AID is a problem, if the A/D converters are used without proper filters. If recording is done with 48 kHz sampling, the Aliasing distortion will be at frequencies above 20 kHz. This will be a problem when working with the audio signals in the sound studio, where the monitored signals will have AID.

If digital sample-rate conversion is used to generate the 44.1 kHz master version from 48 kHz source material, AID will not occur since the alias products are filtered by the sample rate converter alias filter assuming of course that a good quality sample-rate converter is used.

Not many A/D converters are available with NF stop-band filtering. As mentioned in the abstract, the majority of converters have 0.45/0.55 anti-alias filters, which will result in AID. One converter chip is however available today with NF stop-band filtering, and that is the CS5397 from Crystal Semiconductors.

This topic of AID and the influence of sampling bandwidth on the sound quality is something that needs to be investigated further, since to our knowledge documented test results are not available. This is however a subject in which Digital Audio Denmark will conduct more research in the future.

Digital Audio Denmark A/D converters

The ADDA 2402 A/D, D/A and D/D converter from Digital Audio Denmark has implemented NF stop-band filtering for eliminating the risk of AID. This means that digital recordings can be made without aliasing distortion. However, a trade-off has to be made concerning the bandwidth of the sampled signal. When sampling with 44.1 kHz the transition band starts at 18.1 kHz, and the attenuation at 20 kHz is 12 dB. This means that the signal 3 dB bandwidth is reduced to 19.3 kHz.

References

- [1] R. Blake: “Anti-alias filters: the invisible distortion mechanism in digital audio”. Preprint 4966, 106th AES Convention, Munich 1999.